

Data Sheet

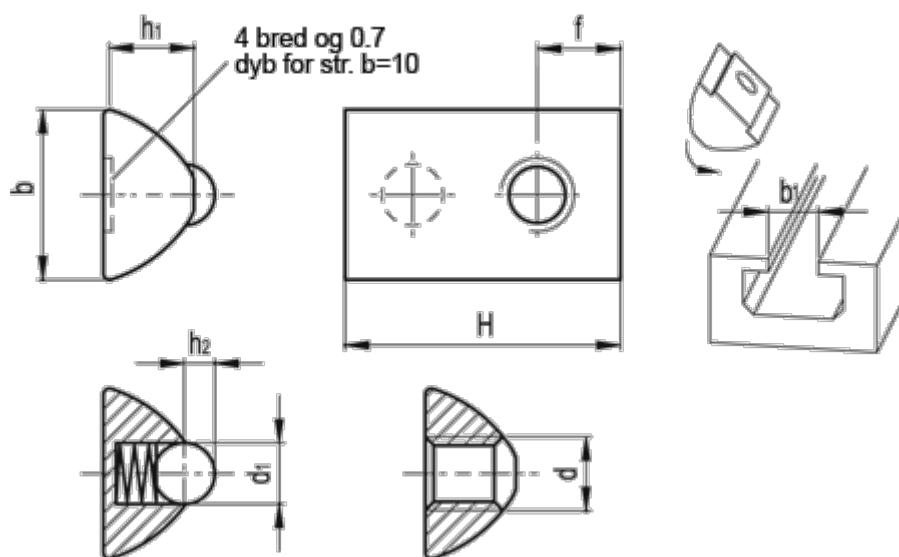

Article number: 200803941
Description: E+G T-nut with guide step
GN 506.1-14-M5-NI
Note: Stainless steel AISI 303

Measures



b = 14 -0.2

b1 = 8

d = M5

d1 = 5

f = 6.8

H +0.5 = 22.5

h1 = 7.40

h2 = 1.7

Weight (g) = 11